

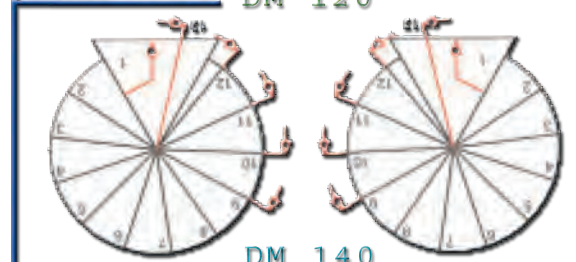

DM 120

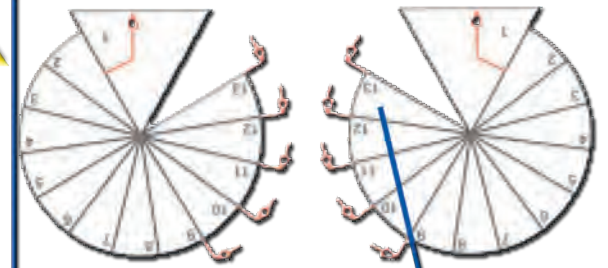

DM 140







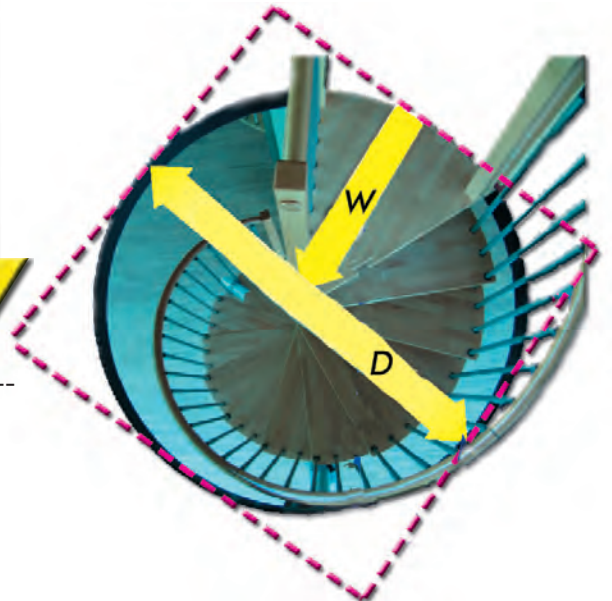



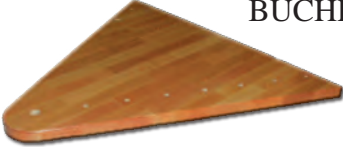

















DM 160







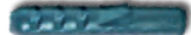





















	9	10	11	12	13
	1980	2200	2420	2640	2860
	-	-	-	-	-
	2142	2380	2618	2856	3094
120	232°	258°	284°	310°	336°
140	236°	262°	288°	314°	340°
160	205°	228°	251°	273°	296°



	W	D
120	600-650 mm	>1200 mm
140	700-750 mm	>1400 mm
160	800-850 mm	>1600 mm

V1		BUCHE 1 x - 933240 1 x - 933242 1 x - 933244	V14		BUCHE 1 x - 933232 950 x 40 mm
V2		BUCHE 12 x - 933239 12 x - 933241 12 x - 933243	V15		2 x - 931884 90 x 90 x 80 x 3 mm
V3		1 x - 933129 910 x 50 x 1 mm	V16		1 x - 931883 ø 100 x 3 d21 mm
V4		1 x - 920924 ø 60,2 x 1050 mm	V17		1 x - 930707 M20 x 1210 mm
V5		1 x - 931881 ø 60,2 mm	V18		1 x - 930654 M20 x 900 mm
V6		1 x - 920915 ø 51 x 2,6 x 220 mm	V19		11 x - 933230 15 x 50 mm
V7		1 x - 931886 ø 51 x 2,6 x 220 mm	V20		13 x - 933130 M10 x 120 mm
V8		16 x - 933238 ø 22 x 1 x 840 mm	V21		1 x - 932143 M20 x 60 mm, DIN 6334
V8a		1 x - 932118 ø 22 x 1 x 840 mm	V22		104 x - 930698 ø 127 x 3 mm
V9		5 x - 933237 ø 6 x 6000 mm	V23		3 x - 933218
V10		13 x - 931889 ø 127 x 2,9 x 179 mm	V24		16 x - 933216
V11		14 x - 933134 ø 22 x 1 x 175 mm	V25		2 x - 933215 ø 50 mm
V12		1 x - 933145 ø 22 x 70 mm	V26		16 x - 933217
V13		BUCHE 12 x - 933221 12 x - 933222 12 x - 933223	V27a		10 x - 930303 ø 8 mm



V27b		2 x - 930687 ø 12 mm	V40		3 x - 931735 M8 x 55 mm - DIN 933
V28		1 x - 931586 ø 22 mm	V41		6 x - 931879 M8 x 55 mm - DIN 6912
V29		1 x - 933219 ø 35 mm	V42		16 x - 932139 M5 x 20 mm - DIN 7991
V30		1 x - 930629 M20 - DIN 934	V43		6 x - 932141 M6 x 6 mm - DIN 914
V30a		1 x - 932145 M20	V44		10 x - 932152 ø 6 x 50 mm
V31		BUCHE 4 x - 933231 M8 - DIN 934	V45		10 x - 932153 ø 6 x 30 mm
V32		16 x - 930231 M5 - DIN 934	V46		2 x - 932140 ø 3,9 x 19 mm
V33		1 x - 933233 37 x 28 x 12 mm	V47		84 x - 933131 ø 30 x 3 mm - M10 - DIN 9021A
V34		6 x - 932142 M6 - DIN 562	V48		3 x - 930680 ø 16 - M9 - DIN 125A
V35		3 x - 931733 M8 x 55 mm	V49		8 x - 933025
V36		16 x - 933039 M10 x 70 mm - DIN 6912	V50		59 x - 933229 ø 3,5 x 25 mm
V37		43 x - 933040 M10	V51		80 x - 933228
V38		43 x - 933039	V52		80 x - 933236 M6 x 14 mm
V39		2 x - 930882 M10 x 100 mm	V53		20 x - 933263 ø 8 x 12 mm





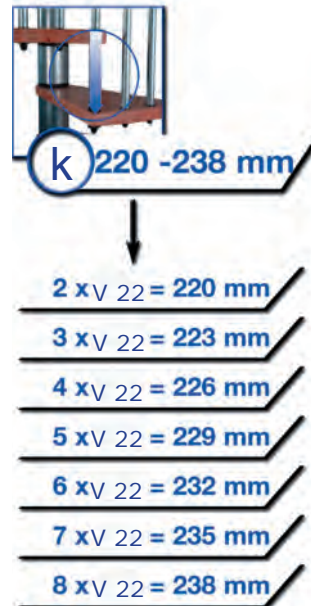
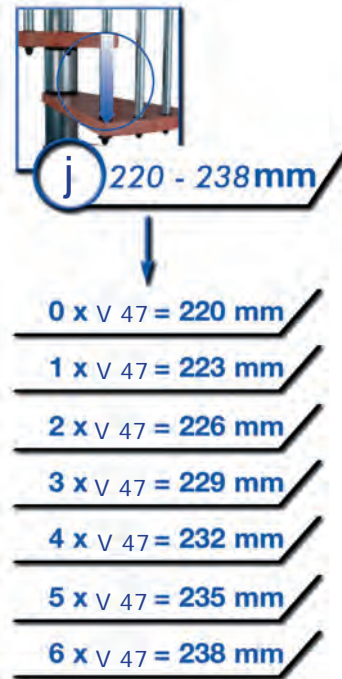
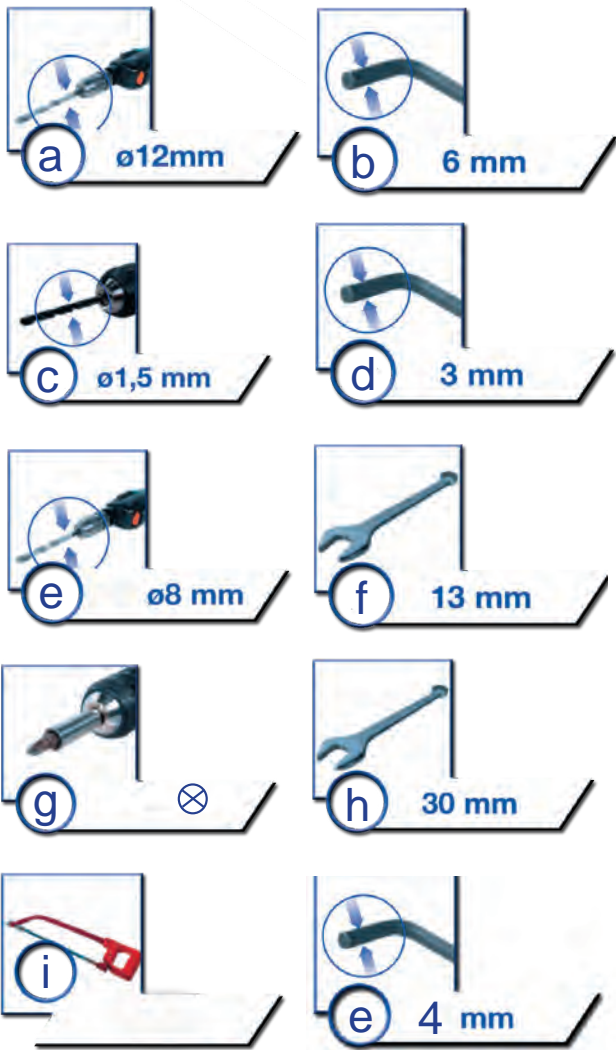

1

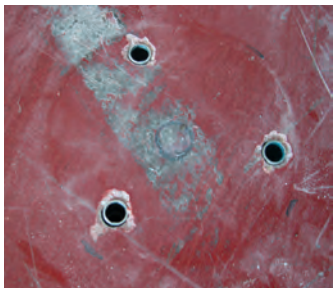
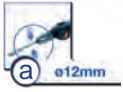

V35



2

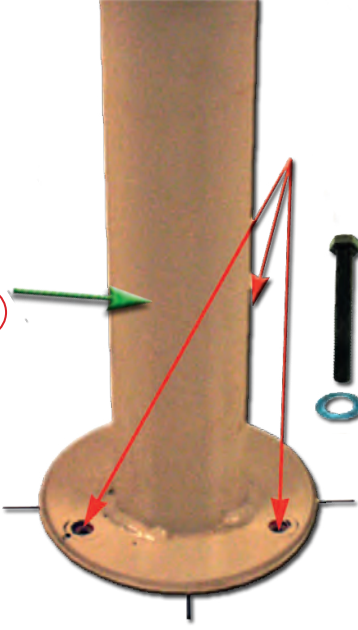
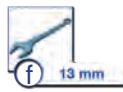

V4

V40

V48



3

V4



V10

4

V2

V22



V22

V4



- 2 x V 22 = 220 mm
- 3 x V 22 = 223 mm
- 4 x V 22 = 226 mm
- 5 x V 22 = 229 mm
- 6 x V 22 = 232 mm
- 7 x V 22 = 235 mm
- 8 x V 22 = 238 mm

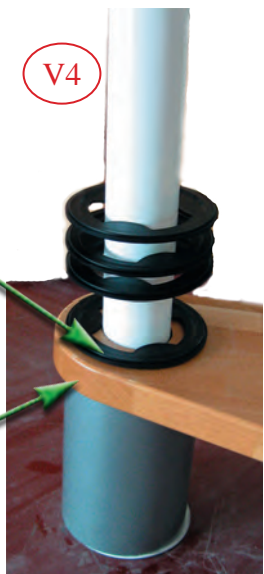

5

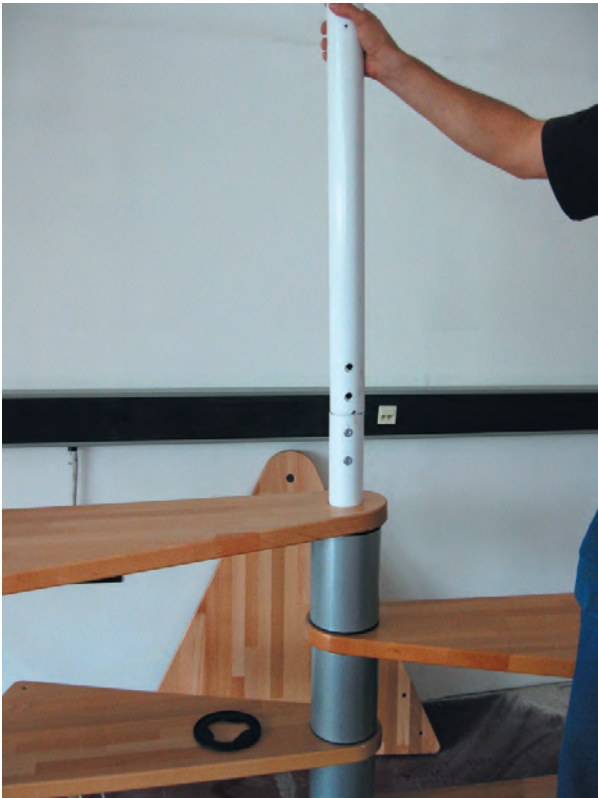
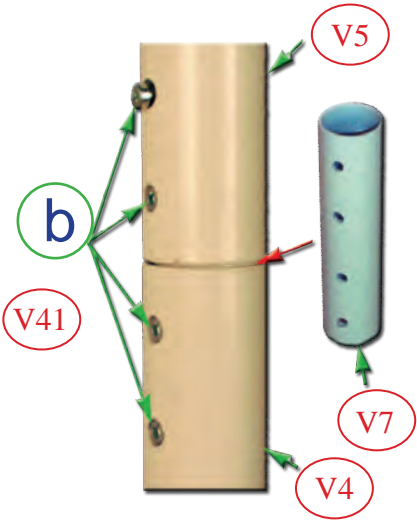
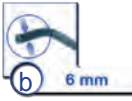

6

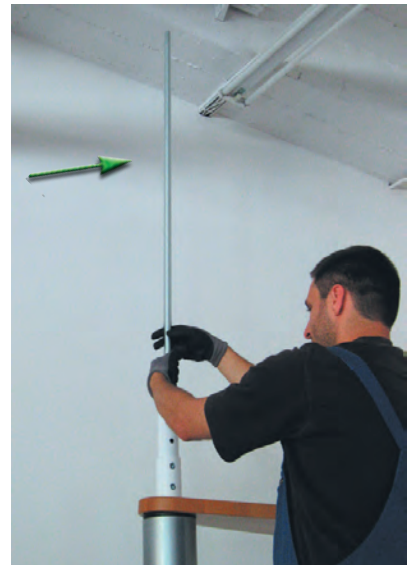
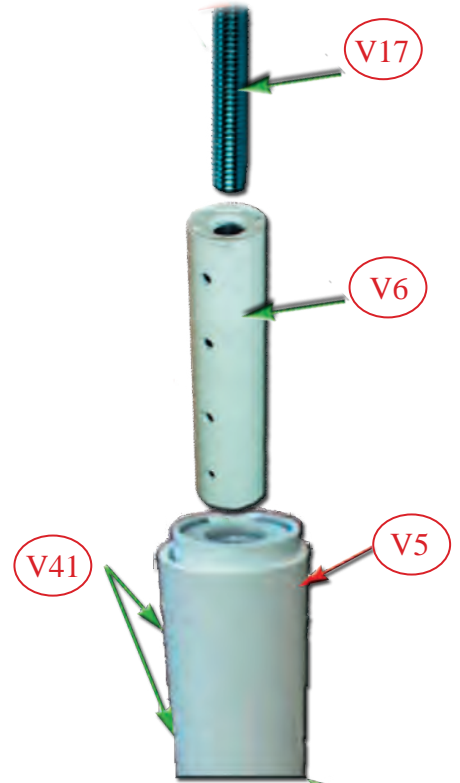
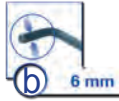



7

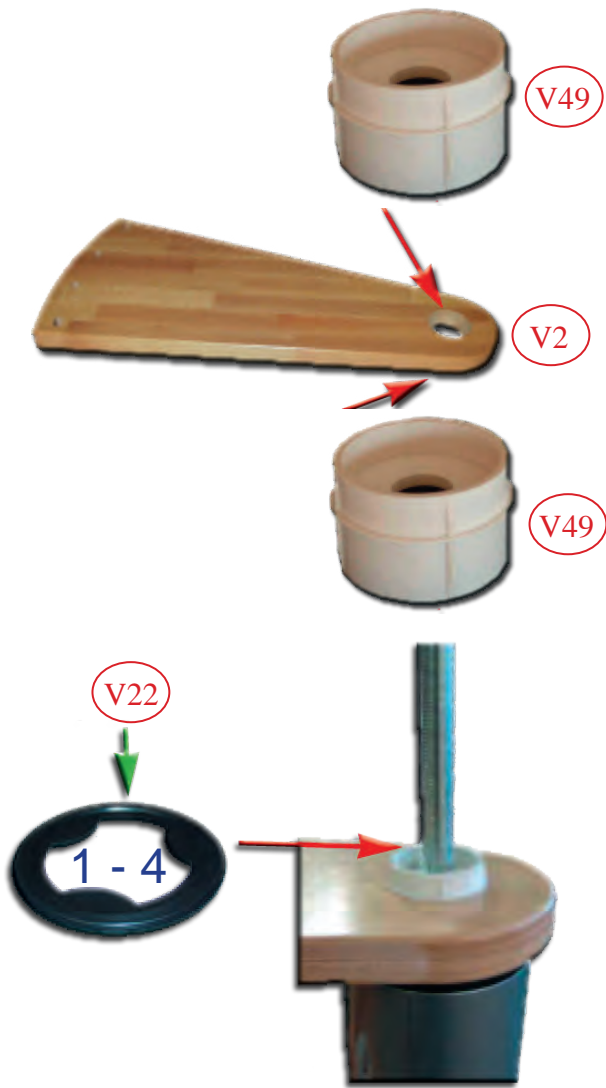

8

V16

V1

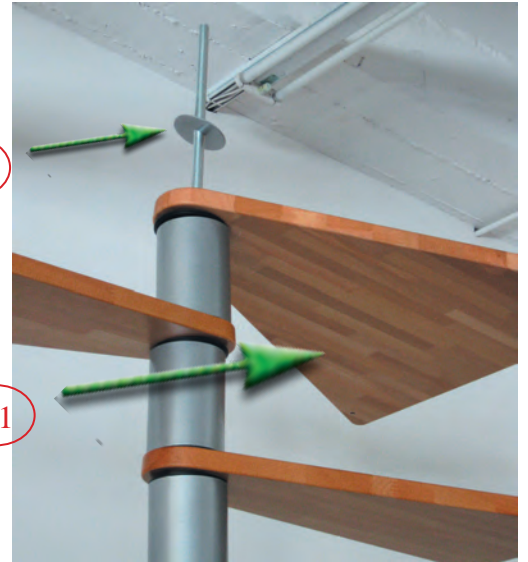

9

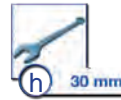

V30

V16

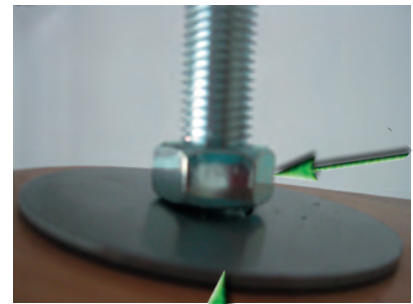

10

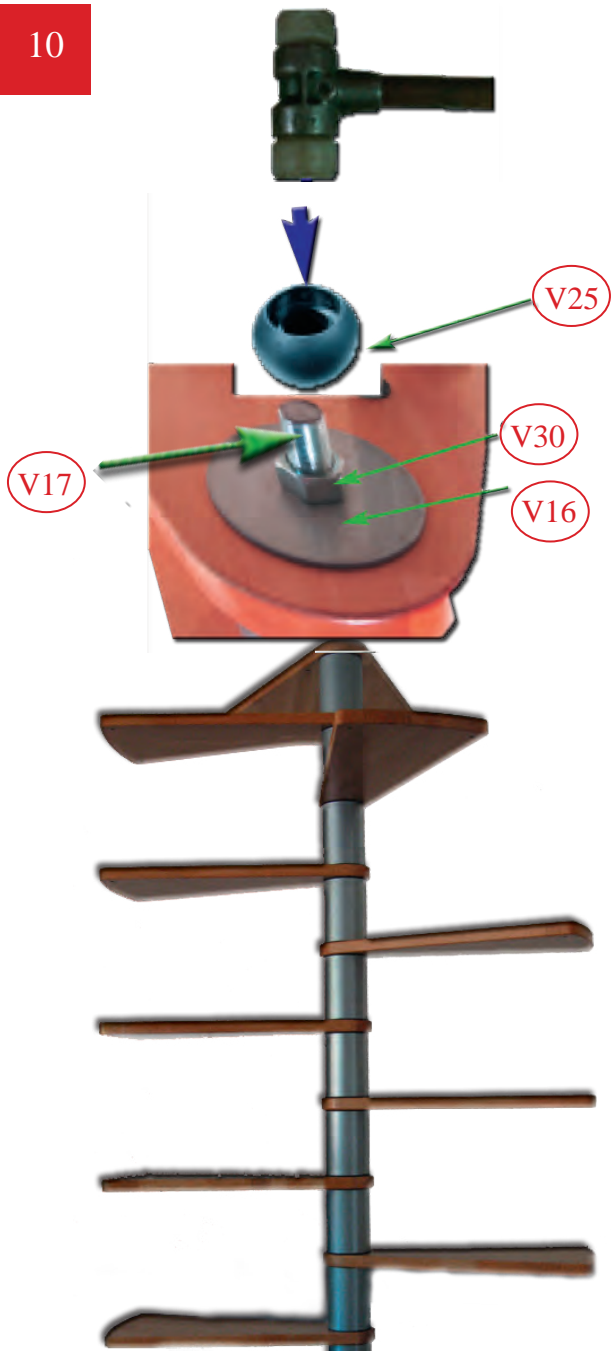

11



V1

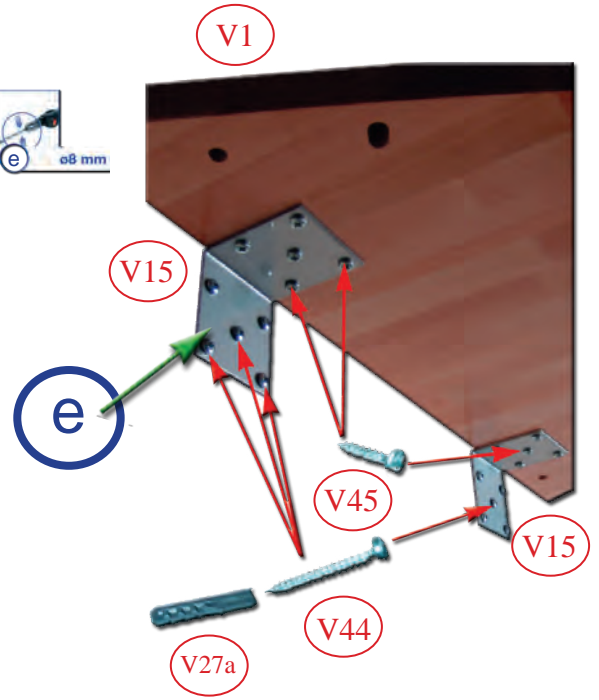
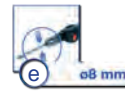



12

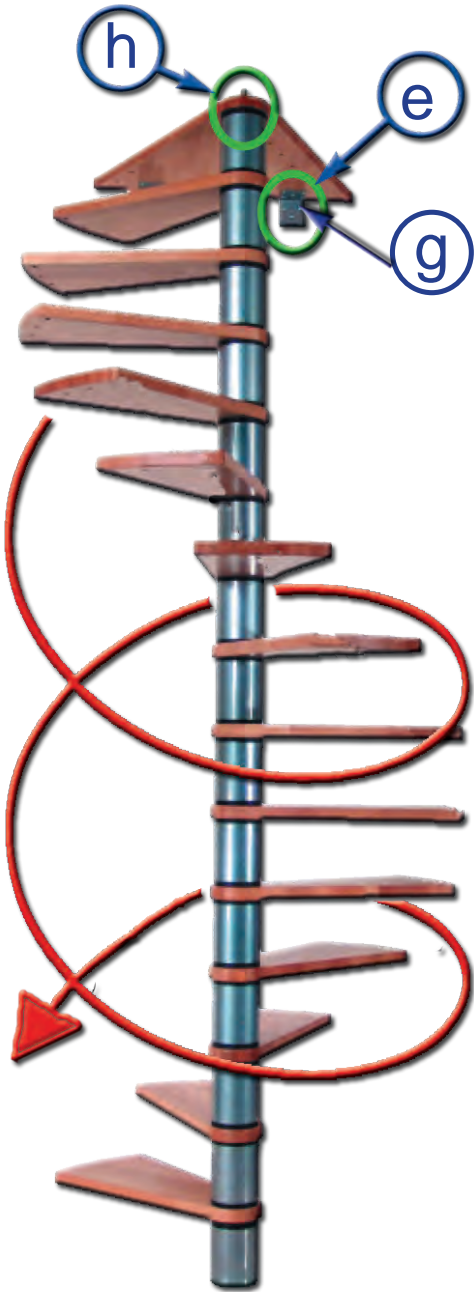

13

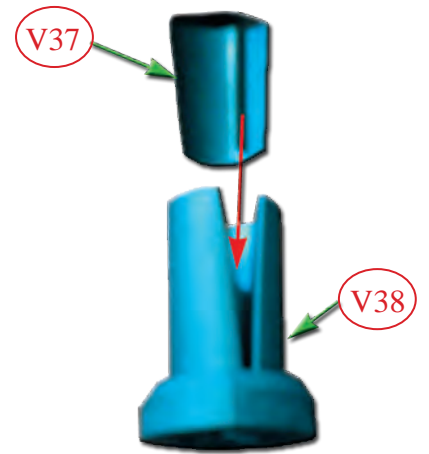

14

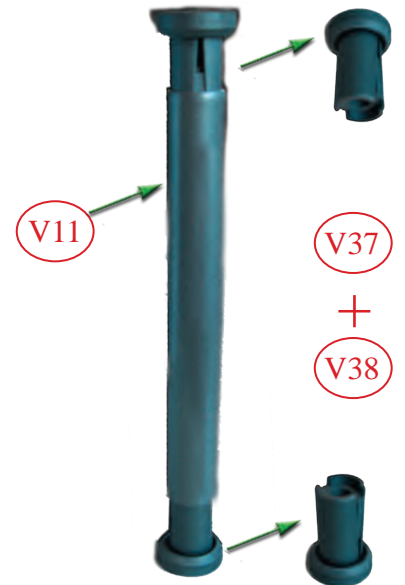

15

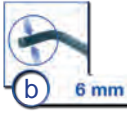

- 0 xV 47= 220 mm
- 1 xV 47= 223 mm
- 2 xV 47= 226 mm
- 3 xV 47= 229 mm
- 4 xV 47= 232 mm
- 5 xV 47= 235 mm
- 6 xV 47= 238 mm

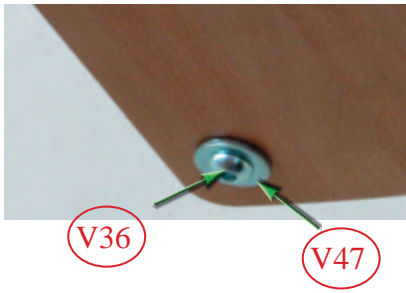
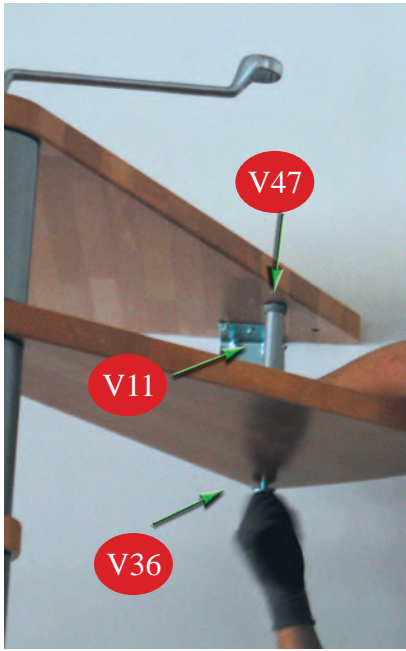

16

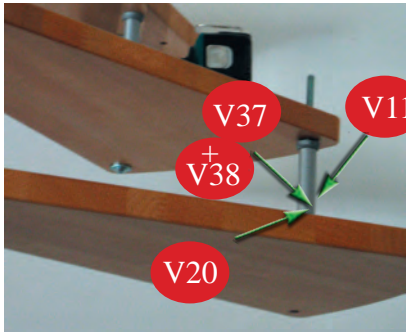

17

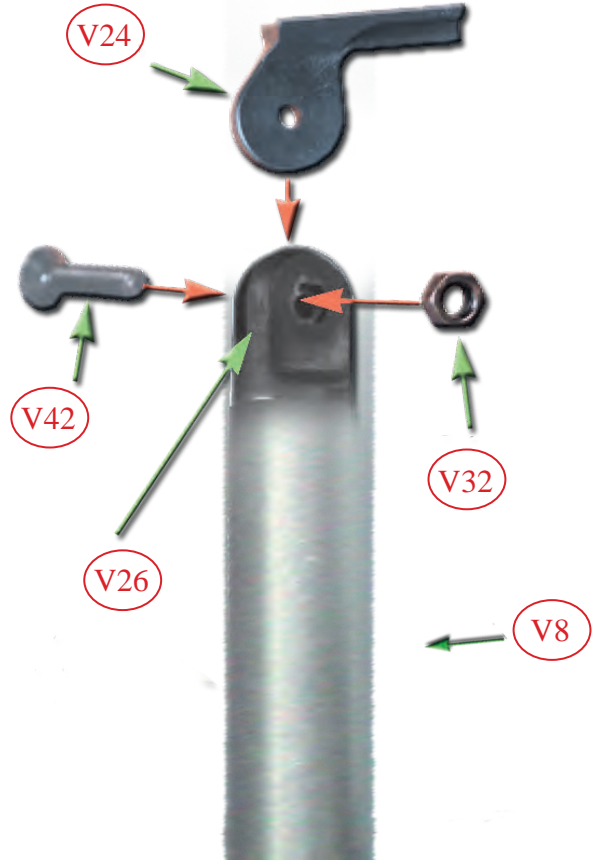
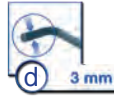

18



19



20

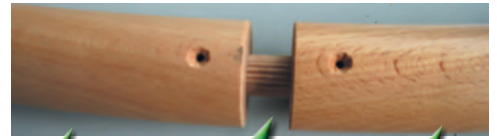

21

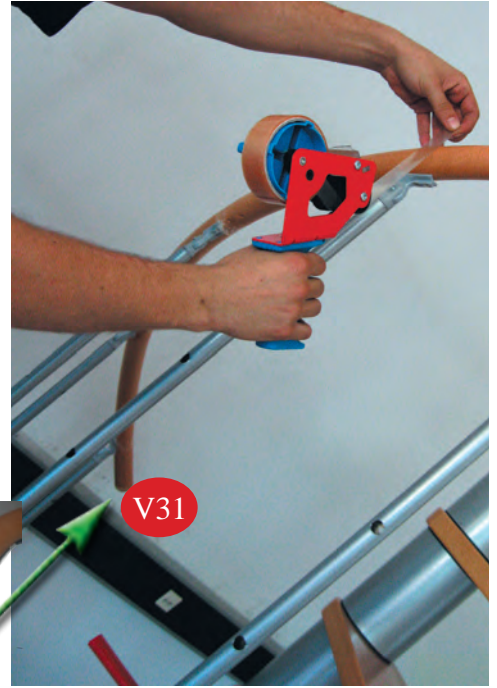



22



24



23



25



26

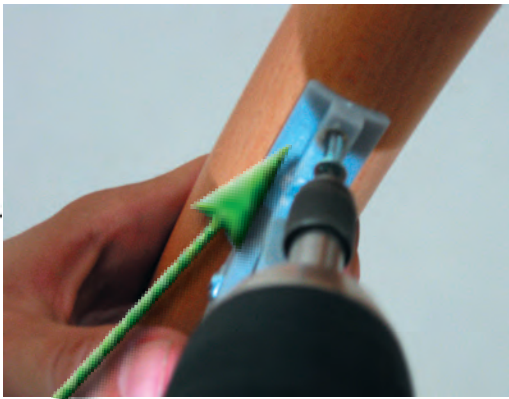

V50

27



28



V13

V50

V8

V9

29



V51



30

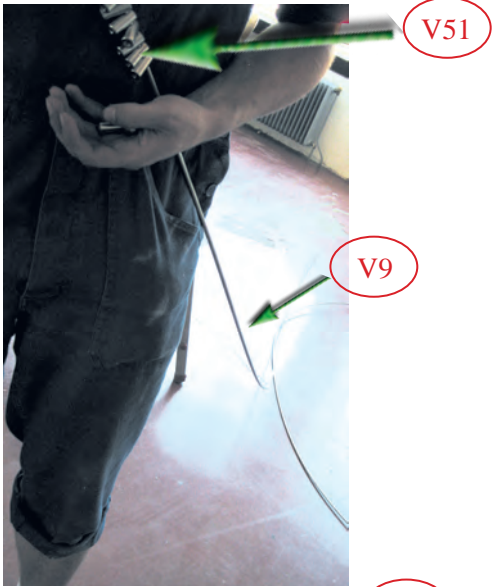

V51

31

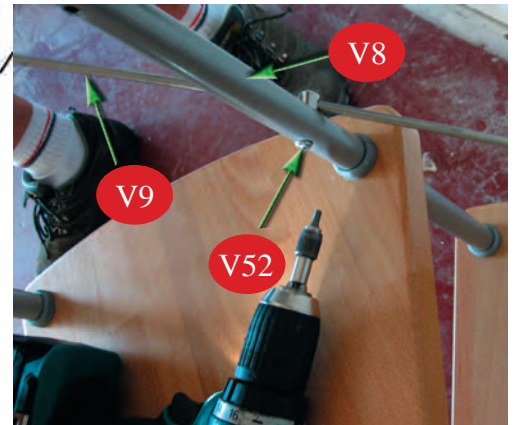
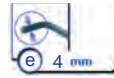
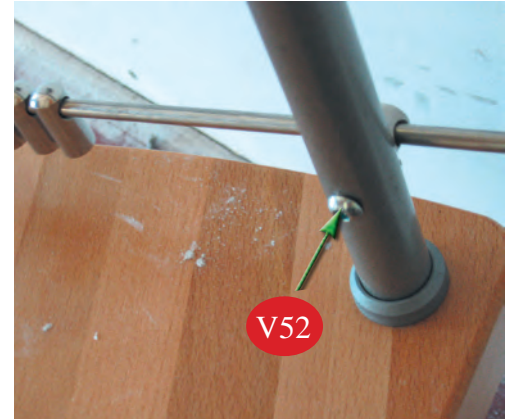
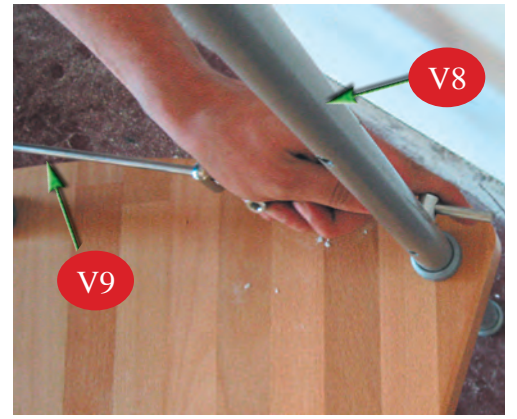
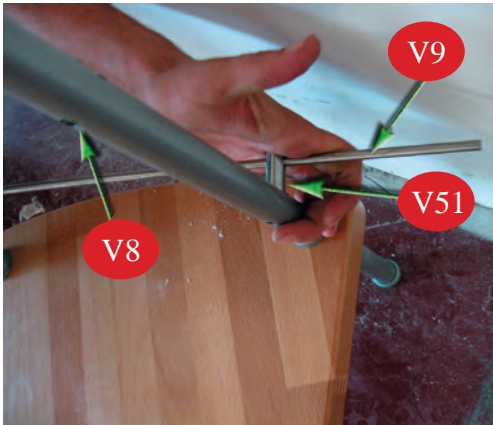



32



33

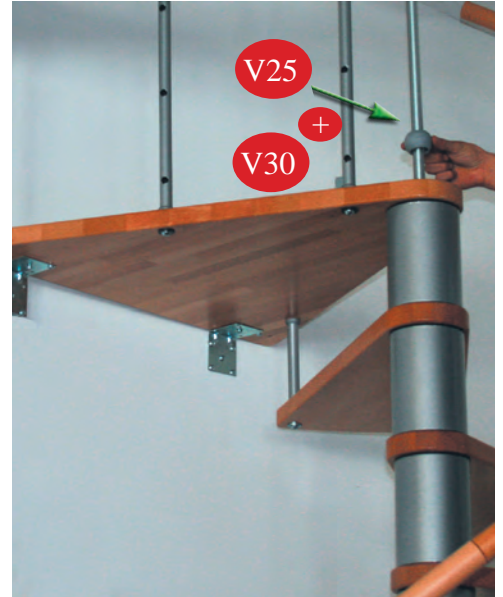

34



35

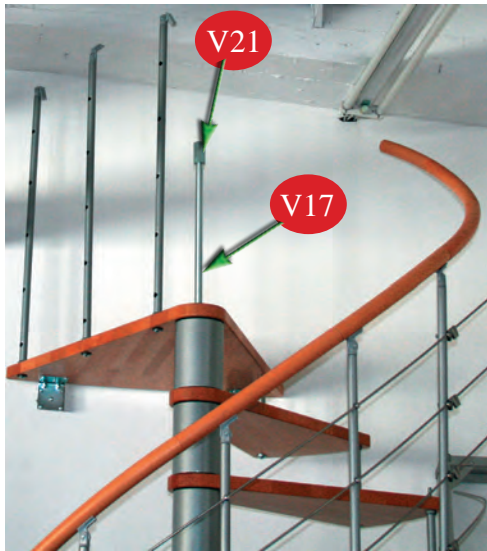

37



36

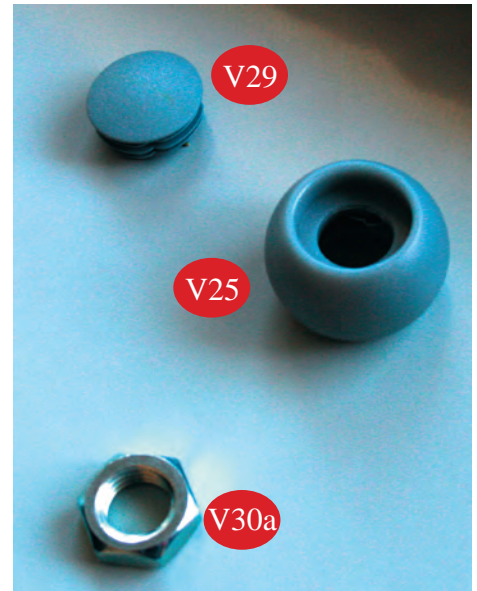



38

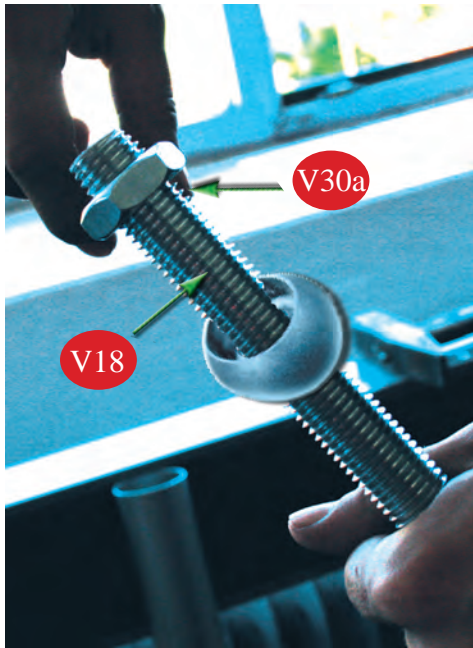

40

V29



39

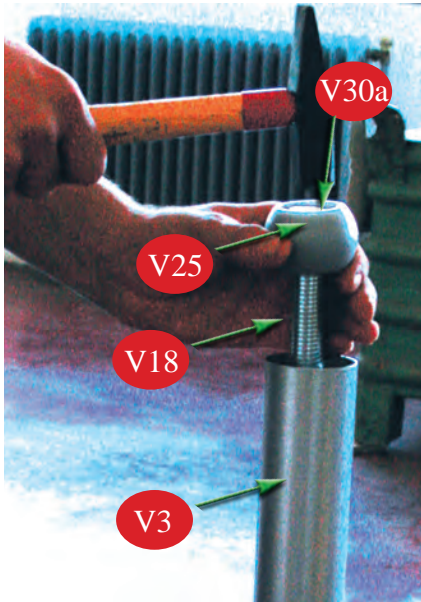

41

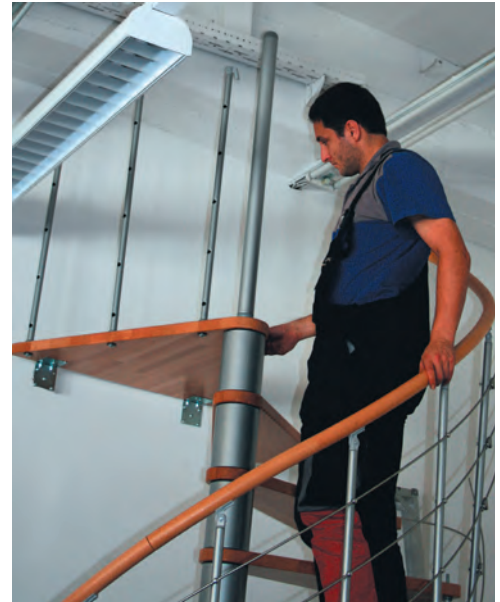



42

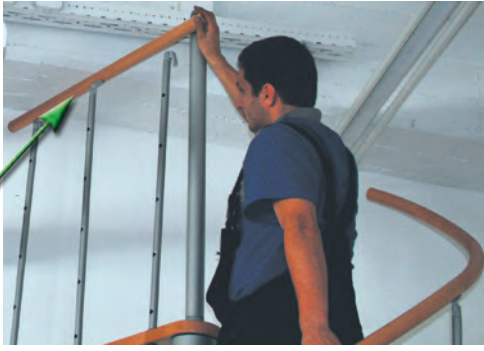

V14

44

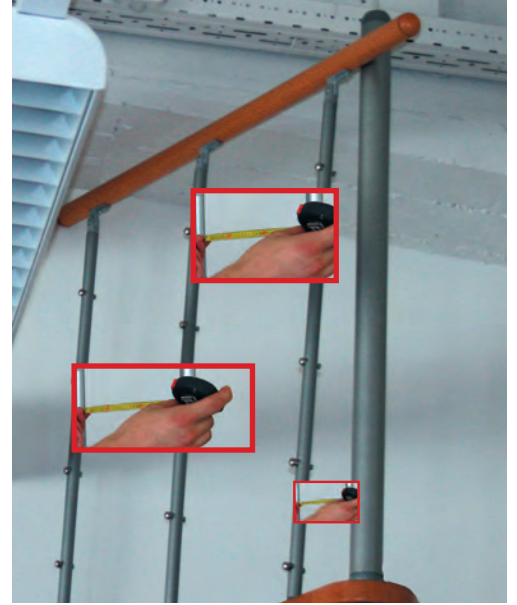

43



V14

V51

45

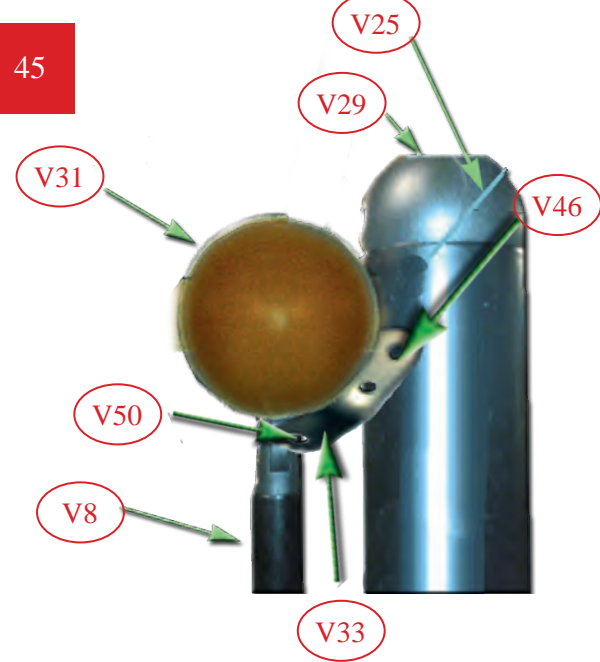

V25

V29

V31

V46

V50

V8

V33



46

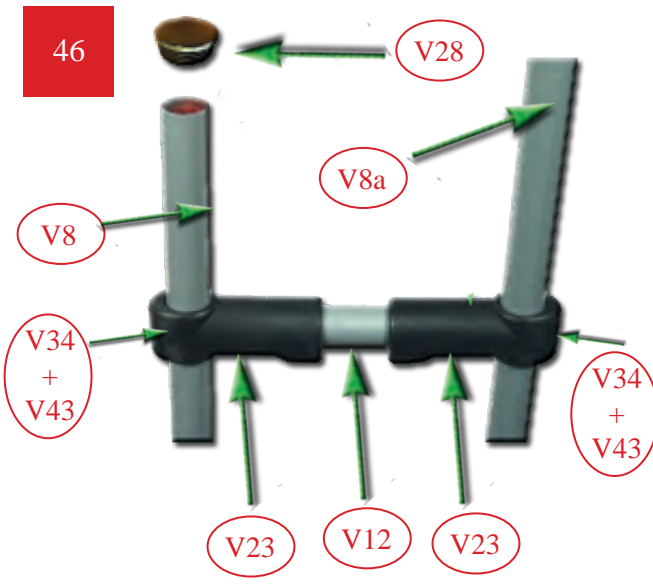

47

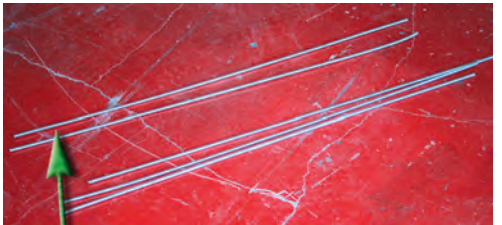

V9

48



V9

49

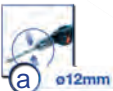

V27b

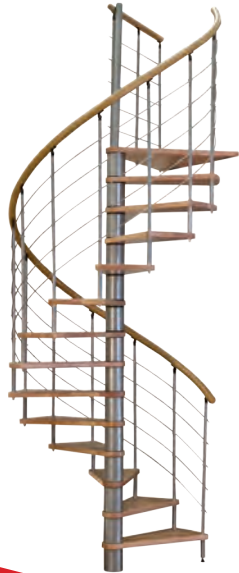
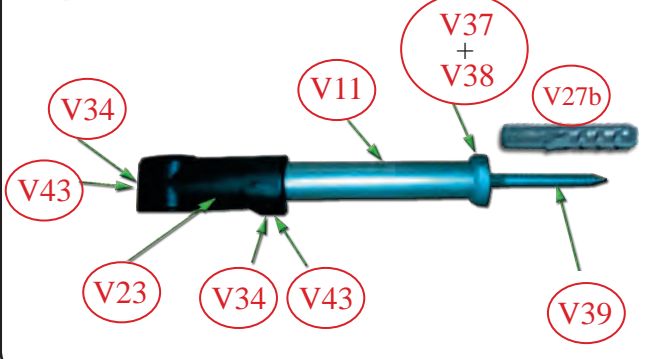



**WERK II  
Kindberg / Austria  
Produktion Raumspartreppen  
& Spindeltreppen**

